

## Absolute Rate Constants of Elementary Reaction Steps in Radiation-Induced Peroxidation of Unsaturated Fatty Acids

Branka Katušin-Ražem\* and Dušan Ražem\*

Department of Chemistry, Ruđer Bošković Institute, 10000 Zagreb, Croatia

Received: June 16, 1999; In Final Form: December 10, 1999

Initial radiation-chemical yields of peroxidation in the homologous series of unsaturated free fatty acids were measured in neat substrates by steady-state irradiation with  $^{60}\text{Co}$   $\gamma$  rays to obtain baseline values of oxidizability pertaining to a pure lipid moiety at 293 K for oleic (OIH), linoleic (LIH), linolenic (LInH), and arachidonic (ArH) acid. Rate constants of individual reaction steps of peroxidation, propagation and termination, were also measured in the same compounds by intermittent irradiation with  $^{60}\text{Co}$  gamma rays by means of a specially built apparatus. The values of these rate constants were found to double as the number of methylenic carbons increased by one so that the relative values of oxidizabilities in the series LIH/LInH/ArH/docosapentaenoic acid (DPA)/docosahexaenoic acid (DHA) increased as  $1:\sqrt{2}:2:2\sqrt{2}:4$ . Literature data on oxidizabilities and the pertaining rate constants were subject to scaling with respect to temperature and solvent effects. Consistent baseline values of these quantities were obtained, indicating that an adequate understanding of the applied corrections was reached. Radiation-induced peroxidation inhibited by a reference antioxidant  $\alpha$ -tocopherol gave radiation-chemical yield of alkyl free radicals  $G(\text{L}^\bullet) = 0.52 \pm 0.16 \mu\text{mol/J}$  in all fatty acids studied. Temperature dependence of the literature data on  $k_p/k_{\text{inh}}$ , corrected for solvent polarity effect on  $k_p$ , together with our own measurements of  $k_{\text{inh}}$  gave Arrhenius activation parameters for the inhibition reaction in pure lipid moiety. The activation energy of the reaction, 4.5 kJ/mol, large negative entropy,  $-138 \text{ J/mol K}$ , and pre-exponential factor  $10^6$  support the view that the mechanism of  $\alpha$ -toc action in nonpolar media may involve both charge and proton transfer.

### Introduction

Prominent characteristics of unsaturated fatty acids (LH) are labile hydrogen atoms weakly bound to carbons adjacent to double bond(s); there are two such (allylic) positions in each unsaturated LH, and  $d - 1$  bisallylic positions (or  $d - 1$  methylene groups) in polyunsaturated fatty acids (PUFA) (where  $d$  is the number of double bonds in the molecule). Bisallylic carbon–hydrogen bond dissociation energy (BDE  $\approx 314 \text{ kJ/mol}$ ) is lower than most other BDEs of hydrogen.<sup>1</sup> This energy can easily be recovered in reactions between unsaturated LH and most free radicals, whereby initiating free radicals become stabilized by abstracting the loosely bound hydrogen from the LH molecule, yielding a more stable nonradical entity and a free radical  $\text{L}^\bullet$ .

The reaction of a free radical  $\text{L}^\bullet$  with oxygen, which in its lowest triplet state has a free radical character itself, is close to a diffusion-controlled process and one of the most important reactions of free radicals in nature, conducive to the process known as lipid peroxidation.<sup>2</sup> Given the facts that unsaturated LH are constitutive parts of lipids forming all biological membranes and plasma lipoproteins and that aerobic conditions prevail in the biosphere, and further, given the ease of the formation of lipid free radicals and the chain mechanism of their reactions with oxygen, the enormous biomedical significance of lipid peroxidation cannot be overemphasized. In addition to that, technoeconomic and health aspects of lipid peroxidation should also be considered in view of the importance of animal

and plant fats and oils in nutrition and various industries. Therefore, it is not surprising that various aspects of lipid peroxidation continue to be the subject of intensive research.

The ability of unsaturated LH to undergo chain oxidation is termed oxidizability. Classical rate laws for autoxidation relate the rate of production of hydroperoxides with the square root of the initiation rate and the concentration of the substrate, and the proportionality factor between the former and the latter two quantities is oxidizability. Oxidizability is a composite quantity defined by the ratio of the propagation rate constant and the square root of the termination rate constant,  $k_p/\sqrt{2k_t}$  (see below).

Consequently, oxidizability does not assume a constant value, but changes according to the effects exerted by the medium on the constitutive chemical reactions (e.g., solvent polarity<sup>3</sup>). Moreover, as the applicability of the classical rate law for autoxidation has been shown to extend to membrane model systems, micelles and lipid bilayers,<sup>4</sup> as well as to erythrocyte ghost membranes,<sup>5</sup> in each of these systems, for any set of experimental variables (concentration, pH) a corresponding value of oxidizability could be established.

Is there a “baseline” value of oxidizability? We believe that such a value should be defined in a pure lipid phase, and this paper is an attempt to establish these “baseline” values in a series of neat LHs by means of radiation chemistry methods. Irradiation with  $^{60}\text{Co}$   $\gamma$  rays is a particularly suitable method of initiation, because the addition of any potentially interfering substance to oxidizing substrates can thus be completely avoided.

\* Corresponding author. Phone: 385-1-4561-154. Fax: 385-1-4680-098. E-mail: razem@rudjer.irb.hr.

Considering that oxidizability in radiation-induced peroxidation is proportional to radiation-chemical yield of hydroperoxides (see below), the oxidizability data extractable from the existing studies on radiation-induced peroxidation in bulk fatty acids,<sup>6</sup> their homogeneous solutions,<sup>7,8</sup> micelles,<sup>8-10</sup> liposomes,<sup>11,12</sup> and membranes<sup>13</sup> should be consistent with oxidizability data extractable from autoxidation studies performed in these systems under the same conditions. However, various measurement methodologies and a variety of products measured in this type of study<sup>14</sup> resulted in poor mutual consistency; in addition to that, the restriction of most studies to individual fatty acids further obscured the expected regularity within the series. Moreover, a few (incomplete) homologous series differ between themselves, and discrepancies are even larger if irradiation data<sup>15,16</sup> are compared to autoxidation data.<sup>17</sup>

Reliable values of the absolute rate constants of individual steps in peroxidation of a particular LH are needed for establishing quantitative relationships between structure and reactivity and for kinetic modeling of autoxidation processes.<sup>18,19</sup> However, the individual rate constants  $k_p$  and  $k_t$  cannot be separated easily. This task requires the measurement of the lifetime of the chain reaction, and this type of measurement with absolutely pure LH, without any additives, was not performed so far in a complete series of unsaturated LH.

Previous measurements of chain oxidation lifetimes (and of termination rate constants derived from them) relied on photochemical activation of free radical initiators in bulk LH,<sup>20</sup> their solutions,<sup>21</sup> or aggregates.<sup>22</sup> The present work is the first attempt to systematically study radiation-induced peroxidation in a series from mono- to polyunsaturated LH and to measure the absolute rate constants of elementary steps involved in the process. The advantages of radiation-induced peroxidation are that initiation is started homogeneously, at room temperature, without any additives and at a constant, well-known, and controllable speed.

Contrary to previous measurements, which were chiefly based on continuous monitoring of the consumption of oxygen, in this work the peroxidation was followed by measuring radiation-chemical yields of hydroperoxides (LOOH) formed. Hydroperoxides are the primary products of peroxidation and are directly related to the fate of LH undergoing the process. A sensitive spectrophotometric method for the quantification of LOOH modified by us<sup>23</sup> allowed the initial stages of the process to be followed accurately, at conversions of LH into LOOH not exceeding a few percent. It also afforded the data for mono- and bisunsaturated LHs comparable to the data obtained for polyunsaturated LH, because the same analytical method was applied throughout the homologous series of LH; that would not have been possible if the more popular malondialdehyde or conjugated dienes methods had been applied for analysis of hydroperoxides. In the absence of initiator and solvent influences, which were eliminated from the present study due to the direct initiation by radiation energy, absolute values of the rate constants, believed to reflect true molecular properties of LH, were obtained for the first time.

### Kinetics of Radiation-Induced Peroxidation

Because of the nonselective action of ionizing radiation, the first generation of radicals ensuing from the interaction of ionizing photons and unsaturated LH may not necessarily be all centered on the carbon atoms adjacent to double bonds. Most radicals of the next generation, however, are likely to result from the abstraction of the weakest bound (methylenic or allylic) hydrogen, because this reaction would be both thermodynamically and kinetically preferred.

After the initial production of free radicals by radiation initiation,



the subsequent steps in a peroxidation chain process are as follows:

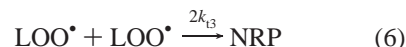
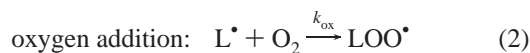

We are interested in the rate of formation  $R$  of the product LOOH, for which the following expression applies:

$$R = d[\text{LOOH}]/dt = G(\text{LOOH})\rho P = k_p[\text{LH}][\text{LOO}^\bullet] \quad (7)$$

relating it with the experimentally measurable quantities, the radiation-chemical yield of LOOH,  $G(\text{LOOH})$  (moles of LOOH formed per unit dose in gray), density,  $\rho$ , and dose rate,  $P$ .

The application of the steady-state approximation to the intermediate free radicals  $\text{LOO}^\bullet$  and  $\text{L}^\bullet$  gives the expression for the rate of formation of alkyl free radicals:

$$G(\text{L}^\bullet)\rho P = (\sqrt{2k_{t1}}[\text{L}^\bullet] + \sqrt{2k_{t3}}[\text{LOO}^\bullet])^2 \quad (8)$$

provided that

$$2k_{t1}2k_{t3} = k_{t2}^2 \quad (9)$$

Condition 9 has been recognized already by Bolland.<sup>24</sup>

Steady-state concentration of alkyl radicals  $\text{L}^\bullet$  can be found after taking the square root of the expression 8; having thus expressed one unknown ( $[\text{L}^\bullet]$ ) in terms of the other ( $[\text{LOO}^\bullet]$ ), the steady-state equation for peroxy radical can be solved for  $[\text{LOO}^\bullet]$ , which ultimately gives the final expression for  $G(\text{LOOH})$ ,

$$G(\text{LOOH}) = \frac{k_p[\text{LH}]}{\sqrt{\rho P}} \frac{[\text{O}_2]\sqrt{G(\text{L}^\bullet)}}{\sqrt{2k_{t3}[\text{O}_2]^2 + \frac{2k_p k_{t2}[\text{LH}][\text{O}_2]}{k_{\text{ox}}} + \frac{k_p^2 2k_{t1}[\text{LH}]^2}{k_{\text{ox}}^2}}} \quad (7a)$$

Two extreme cases should be considered.

**a. Low Concentration of Oxygen.** Under these conditions, the third term under square root in the denominator of (7a) is far greater than the first two terms, which both contain the concentration of oxygen, and, consequently, can be neglected. The radiation-chemical yield is reduced to

$$G(\text{LOOH}) = (k_{\text{ox}}/\sqrt{2k_{t1}})[\text{O}_2]\sqrt{G(\text{L}^\bullet)}/\rho P \quad (7b)$$

The inverse square-root dependence of  $G(\text{LOOH})$  on dose rate applies under reduced oxygen conditions and cannot be used to distinguish between peroxidation under normal oxygenation and hypoxic conditions.

**b. High Concentration of Oxygen.** The argument contrary to that exposed under (a) above holds, i.e.,

$$2k_{13}[\text{O}_2]^2 \gg 2k_p k_{12}[\text{LH}][\text{O}_2]/k_{\text{ox}} + k_p^2 2k_{11}[\text{LH}]^2/k_{\text{ox}}^2$$

which leads to the following expression for the radiation-chemical yield of LOOH:

$$G(\text{LOOH}) = k_p/\sqrt{2k_{13}[\text{LH}]} \sqrt{G(\text{L}^*)/\rho P} \quad (7c)$$

The ratio  $k_p/\sqrt{2k_{13}}$  is termed *oxidizability* and is directly proportional to  $G(\text{LOOH})$ .

Kinetic chain length  $\nu$  is the measure of how many times the primarily produced radical  $\text{L}^*$  afforded the product LOOH,

$$\nu = \text{rate of propagation}/\text{rate of initiation} \\ = k_p[\text{LOO}^*][\text{LH}]/G(\text{L}^*)\rho P \quad (10)$$

Under high concentration of oxygen, the steady-state concentration of peroxy radicals is given by

$$[\text{LOO}^*] = \sqrt{G(\text{L}^*)\rho P/2k_{13}} \quad (11)$$

Substitution of (11) into (10) gives a convenient form for  $\nu$ ,

$$\nu = (k_p/\sqrt{2k_{13}})[\text{LH}]\sqrt{G(\text{L}^*)/\rho P/G(\text{L}^*)\rho P} \\ = G(\text{LOOH})/G(\text{L}^*) \quad (10a)$$

**Inhibited Peroxidation.** In the presence of a chain-breaking antioxidant AH, the following reaction competes with propagation:



Some inhibitors are capable of inactivating more than one (generally,  $n$ ) peroxy radicals by additional reactions. If there is one additional reaction, such as



the effective concentration of antioxidant in this particular case is  $2[\text{AH}]$ , i.e.,  $n = 2$ . In the dose range in which inhibited peroxidation takes place, the steady-state approximation takes the form

$$-dn[\text{AH}]/dt = G(\text{L}^*)\rho P \quad (14)$$

Noting that the time in which antioxidant will be completely destroyed,  $t_{\text{inh}}$ , can be expressed as the quotient of the characteristic dose of inhibition  $D_{\text{inh}}$  and dose rate  $P$ ,  $t_{\text{inh}} = D_{\text{inh}}/P$ , the eq 14 can be integrated in the following way:

$$\int_0^{D_{\text{inh}}} dD = -(1/G(\text{L}^*)\rho) \int_{n[\text{AH}]}^0 dn[\text{AH}] \quad (14a)$$

which gives

$$D_{\text{inh}} = n[\text{AH}]/G(\text{L}^*)\rho \quad (14b)$$

The expression 14b allows the ascertainment of the radiation-chemical yield of initiating radicals  $G(\text{L}^*)$  from the experimentally obtainable  $D_{\text{inh}}$  for a particular antioxidant, provided  $n$  is known. It is noteworthy that  $G(\text{L}^*)$  does not depend on dose rate.

In inhibited radiation-induced peroxidation, the rate of product formation is

$$d[\text{LOOH}]_{\text{inh}}/dt = G(\text{LOOH})_{\text{inh}}\rho P \\ = k_p[\text{LH}][\text{LOO}^*] + k_{\text{inh}}[\text{AH}][\text{LOO}^*] \quad (15)$$

The application of the steady-state approximation gives

$$G(\text{L}^*)\rho P = k_{\text{inh}}[\text{AH}][\text{LOO}^*] + k_{13}[\text{LOO}^*][\text{A}^*] \quad (16)$$

Steady-state concentration of peroxy radicals in inhibited peroxidation follows from (16) as

$$[\text{LOO}^*] = G(\text{L}^*)\rho P/(k_{\text{inh}}[\text{AH}] + k_{13}[\text{A}^*]) \quad (16a)$$

The application of the steady-state approximation to  $\text{A}^*$  radicals gives

$$[\text{A}^*] = k_{\text{inh}}[\text{AH}]/k_{13} \quad (17)$$

This leads to the following expression for the inhibited radiation-chemical yield of LOOH:

$$G(\text{LOOH})_{\text{inh}} = G(\text{L}^*)\rho/n\{1 + k_p[\text{LH}]/k_{\text{inh}}[\text{AH}]\} \quad (15a)$$

In the inhibited dose range, the radiation-chemical yield of LOOH does not depend on the dose rate.

The expressions for uninhibited (7c) and inhibited oxidation (15a) and inhibition dose (14b) in radiation-induced peroxidation are exact parallels of the expressions applicable to the corresponding rates in autoxidation and inhibition time, respectively. The rate of initiation in autoxidation is changed to the rate of production of the initiating radicals,  $G(\text{L}^*)\rho P$ , in radiation-induced peroxidation, and the time of inhibition is changed to inhibition dose  $D_{\text{inh}}$ .

**Intermittent Irradiation.** The rate of radiation-induced peroxidation is not directly proportional to dose rate; the square-root dependence on the dose rate comes from the second-order character of the radical recombination process. Because of this, the rate of product formation is sensitive to the spatial/temporal distribution of radiation energy absorption in the system.

At uniform irradiation, the rate of product formation  $R$  is given by (7). However, the irradiation can be done in cycles consisting of an irradiated and a shielded interval, so that

$$r = \text{shielded interval}/\text{irradiated interval} \quad (18)$$

Under conditions of slow exchange of irradiated and shielded intervals, the rate of product formation within the cycle,  $R_{\text{slow}}$ , will be reduced as if the reaction takes place only during the irradiated interval

$$R_{\text{slow}} = K\sqrt{P}/(r + 1) \quad (19)$$

where  $K$  is a proportionality factor.

If the exchange of irradiated and shielded intervals is fast, the concentration of radicals attained during irradiation will not have time to decay completely during the shielded interval and shall not start from zero in the next cycle. The rate of product formation within the cycle  $R_{\text{fast}}$ , as compared to the uniform irradiation, will be reduced as if the reaction takes place at the effectively lower dose rate

$$R_{\text{fast}} = K\sqrt{P/(r + 1)} \quad (20)$$

The rate of product formation at the fast exchange of irradiated and shielded intervals is always larger than the rate at slow exchange of the intervals,

$$R_{\text{fast}}/R_{\text{slow}} = \sqrt{r+1} \quad (21)$$

Experimentally, the ratio 21 is the ratio of the  $G(\text{LOOH})$  values obtained under the corresponding conditions of the exchange speed of irradiated and shielded intervals.

Steady-state approximation applied to one complete cycle states that the increase of radicals during the irradiated interval is equal to the decrease of radicals during the shielded interval:

$$k_p[\text{LOO}^*]_{\text{ss}} = 2k_{t3}[\text{LOO}^*]_{\text{ss}}^2 \quad (22)$$

If radical lifetime  $\tau$  is used instead of  $1/k_p$  in (22), it follows that

$$\begin{aligned} \tau &= [\text{LOO}^*]_{\text{ss}}/2k_{t3}[\text{LOO}^*]_{\text{ss}}^2 \\ &= (\text{steady-state concentration of radicals})/ \\ &\quad (\text{rate of removal of radicals}) \quad (22a) \end{aligned}$$

with the steady-state concentration of radicals being given by (11), it follows that

$$\tau = 1/\sqrt{2k_{t3}G(L^*)\rho P} \quad (22b)$$

This expression relating the lifetime of  $\text{LOO}^*$  and the termination rate constant was used to evaluate the latter.

The lifetime of radicals  $\tau$  is proportional to the duration of irradiated interval  $\lambda$ , and the proportionality factor is the reciprocal value of the dimensionless parameter  $m$ ,

$$\tau = \lambda/m \quad (23)$$

The dimensionless parameter  $m$  relates the maximum and the minimum concentrations of radicals attained during the irradiated and shielded intervals, respectively, with the steady-state concentration. The ratio of the average radical concentration over the whole cycle and the steady-state concentration can be expressed in terms of  $m$  and  $r$  only.<sup>25</sup> The values of this ratio can be plotted as a function of  $\log m$  for an experimentally set value of  $r$ ; the ratios of experimentally obtained  $G(\text{LOOH})$  values ( $G_{\text{slow}}/G_{\text{fast}}$ ) can then be plotted as a function of (experimentally known)  $\log \lambda$  on the same graph.  $\log \tau$  follows as the horizontal distance between the two curves,

$$\log \tau = \log \lambda - \log m \quad (23a)$$

Equation 22b is then used to calculate  $k_{t3}$ , eq 7c to calculate  $k_p$ , and eq 15a to calculate  $k_{\text{inh}}$ .

## Experimental Section

Radiation-induced oxidations of oleic acid (OIH), linoleic acid (LIH), linolenic acid (LInH), and arachidonic acid (ArH) were thoroughly investigated in the present work, together with more limited investigations of the methyl ester of oleic acid (MeOIH), the methyl ester of elaidic acid (MeElH), and the methyl ester of linoleic acid (MeLIH).

Unsaturated fatty acids of the highest purity commercially available were obtained from Aldrich (Milwaukee, WI), Fluka (Buchs, Switzerland), Merck (Darmstadt, Germany), and Sigma (Poole, UK), and were kept at  $-18^\circ\text{C}$  in the dark. After opening, the unused portion was saturated with pure nitrogen before returning to storage. Each batch was checked for impurities; the purity check consisted in effect of measuring the parameters of radiation-induced production of hydroperoxides: the induction dose, the linearity of LOOH accumulation

with dose, the level of hydroperoxidation at zero dose, and the radiation-chemical yield of hydroperoxides,  $G(\text{LOOH})$ .

The reported  $G(\text{LOOH})$  values were obtained as the best straight lines showing the accumulation of LOOH with dose. Small positive intercepts on the ordinate indicated the presence of small quantities of pre-formed LOOH and were subtracted from the radiation-induced LOOH. Some easily oxidizable samples showed a supralinear accumulation of LOOH with dose after extended irradiation. Irradiation time was therefore limited to the dose range in which response was linear. When necessary, purification was carried out by vacuum distillation in a tube oven at about 2 mmHg. Applying these corrections and precautions, all materials, irrespective of the provenience, gave consistent results under the same irradiation conditions. Antioxidant *d,l*  $\alpha$ -tocopherol ( $\alpha$ -toc) was supplied by Fluka and Aldrich and was used as received.

The peroxidation was initiated by irradiation with  $^{60}\text{Co}$   $\gamma$  rays. For steady-state irradiations, three irradiation sources with well-defined geometries of irradiation were used, spanning almost 3 orders of magnitude in dose rate (about 6, 0.11, and 0.012 Gy/s). All sources had a cylindrical geometry of radioactive pencils forming a cavity into which a stand with samples could be introduced, securing fixed and reproducible relative positions of samples in the radiation field. Dose rates in the irradiating positions were established with the ethanol–chlorobenzene dosimetry system<sup>26</sup> and calculated daily taking into account the radioactive decay of  $^{60}\text{Co}$ . The samples, typically 0.5 mL, in open Pyrex test tubes, 16 mm o.d. were bubbled with about 50 mL/min oxygen during irradiation. Small aliquots of irradiated samples were withdrawn at regular intervals during irradiation, and any postirradiation changes were immediately terminated by dilution with a multiply larger volume of solvent,  $\text{CHCl}_3/\text{MeOH}$  (1:1 mol/mol).

Intermittent irradiation was carried out in the chamber of a panoramic  $^{60}\text{Co}$  irradiator. Rather than rotating a sector shield between the radiation source and the sample, the samples themselves were mounted on a 60 cm diameter rotating wheel, which carried the samples with a variable and controllable speed alternately through the irradiation field and behind the massive lead shield. The experimental setup was designed and built by MPO, Zagreb, and is shown schematically in Figure 1. The dose-rate profile of one cycle shown in Figure 2 was taken by irradiating a number of ethanol–chlorobenzene dosimeters positioned every  $7^\circ30'$  on the stationary wheel. Dose rate in the irradiating position, 50 cm from the axis of the irradiation source, was about 0.3 Gy/s, while the irradiated sector of the rotating wheel was  $25.32^\circ$ . This gave the effective irradiation time of  $25.32/360 = 0.07$  of the cycle time, the effective dose rate of about 0.021 Gy/s, and the value of  $r = (360 - 25.32)/25.32 = 13.22$ .

The values of  $G(\text{LOOH})$  in intermittent irradiations were determined in the same way as in steady-state irradiations, i.e., as the slopes of the straight lines, (mmol LOOH/kg LH) vs dose. The dose was calculated as the product, (effective dose rate)  $\times$  (exposure time). Since the effective dose rate was relatively low, exposure times had to be limited so as to avoid autoxidation, which would at higher doses introduce supralinearity of the straight lines describing the accumulation of LOOH with dose.

A steady supply of sufficient oxygen is critical for obtaining meaningful oxidizability data. While an adequate supply of oxygen in steady-state irradiations was maintained by bubbling, this was not feasible on the rotating wheel. The size of samples for intermittent irradiation was selected so as to afford the same radiation-chemical yields of LOOH as those obtained with larger

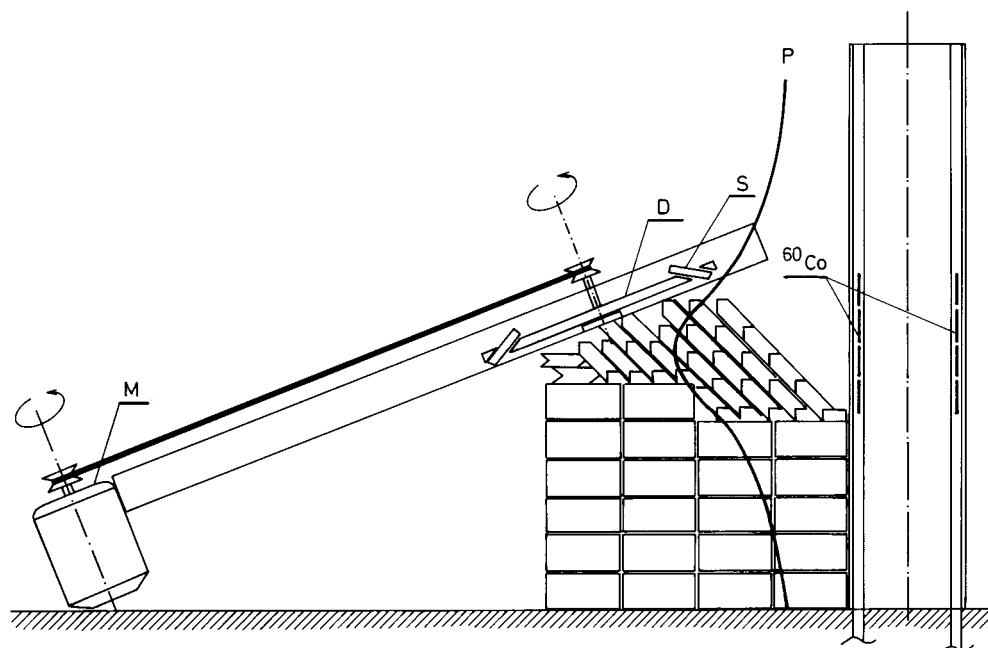

**Figure 1.** Experimental setup for intermittent irradiation: M, motor; D, rotating wheel; S, sample; P, shape of the unshielded dose-rate field in a vertical plane 50 cm from the axis of the irradiation source.

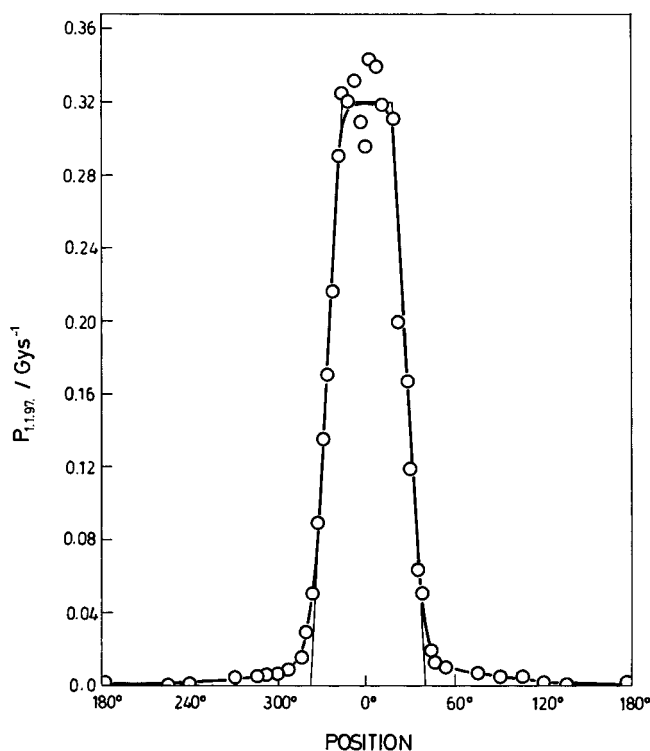

**Figure 2.** Dose rate profile of one cycle in intermittent irradiation.

samples bubbled with oxygen in steady-state irradiations. Decreasing sample size had two effects on the  $G(\text{LOOH})$  values. On one hand, it facilitated the continuous replenishment of oxygen spent in the oxidation reaction by diffusion through the upper, exposed surface of the small volume of liquid sitting on the bottom of the test tube and having the shape of a segment of a sphere. On the other hand, decreasing the size of the sample affected the dose absorbed by the material in a manner described by the cavity theory, so that a progressively increasing contribution to dose was made by secondary electrons from the glass. Eventually, the saturation of the value of  $G(\text{LOOH})$  was reached, corresponding to the  $G(\text{LOOH})$  values obtained in steadily

irradiated samples bubbled with oxygen. In all fatty acids, samples containing 5 mg of LH gave the same  $G(\text{LOOH})$  as 500 mg samples bubbled with oxygen. The intermittent irradiation of a number of small identical samples fixed together on the rotating wheel in any particular run was started at the same time, and individual samples were withdrawn for analysis after having been irradiated for a specified interval of time.

Irradiated samples were analyzed for LOOH by a spectrophotometric ferric thiocyanate method.<sup>23</sup>

## Results

Numerical data on radiation-chemical yields in inhibited and uninhibited radiation-induced peroxidation of neat oleic acid, its methyl ester, and methyl elaidate (neat elaidic acid is solid at room temperature) are outlined in Table 1 as a function of dose rate and  $\alpha$ -toc concentration. Pertaining inhibition doses are also given, as well as the quantities derived from these "primary data", i.e., radiation chemical yields of alkyl radicals,  $G(L^*)$ , and kinetic chain length,  $\nu$ . Corresponding sets of data were obtained for the three other LHs studied in this work, LiH, LinH, and ArH (not shown).

The effect of the dose rate on  $G(\text{LOOH})$  values in samples irradiated in equilibrium with oxygen is shown in Figure 3. The relationship between radiation-chemical yields of LOOH and the inverse square root of the dose rate of the form

$$\log G(\text{LOOH}) = \log G_0(\text{LOOH}) - a \log P \quad (24)$$

holds for all fatty acids and their methyl esters. The values of  $G_0$  and  $a$  are found in Table 2.

In the presence of antioxidant  $\alpha$ -toc, the radiation-induced peroxidation was inhibited until antioxidant was consumed by reactions 12 and 13. The inhibition dose was proportional to the amount of antioxidant present, as required by eq 14b. After the consumption of antioxidant, the peroxidation proceeded with the same radiation chemical yield of LOOH as in uninhibited peroxidation, which was determined by the oxidizability of the fatty acid, Figure 4. In the presence of the same concentration of  $\alpha$ -toc, the same inhibition dose  $D_{\text{inh}}$  was measured in all fatty

TABLE 1: Radiation-Induced Peroxidation of Oleic Acid and Methyl Esters of Oleic and Elaidic Acid

LH	$P$ [Gy/s]	inhibited peroxidation					uninhibited peroxidation				
		$\alpha$ -toc [mmol/kgLH]	dose range [kGy]	no. of expts.	$G(\text{LOOH})_{\text{inh}}$ [ $\mu\text{mol}/\text{J}$ ]	$D_{\text{inh}}$ [kGy]	$G(L^{\bullet})$ [ $\mu\text{mol}/\text{J}$ ]	dose range [kGy]	no. of expts.	$G(\text{LOOH})_{\text{uninh}}$ [ $\mu\text{mol}/\text{J}$ ]	$\nu$
OIH	5.94							0–20	10	$0.72 \pm 0.02$	
	5.94							2–18	5	$0.77 \pm 0.02$	
	5.88							0–20	10	$0.76 \pm 0.01$	
	5.83	0.743	0–1	5	$0.48 \pm 0.08$	2.56	0.57	5–15	6	$0.77 \pm 0.01$	1.34
	5.81	0.885	0–1.4	9	$0.39 \pm 0.02$	3.57	0.50	5–13	4	$0.75 \pm 0.01$	1.51
	5.82	1.113	0–3	6	$0.36 \pm 0.01$	4.38	0.52	5–17	6	$0.77 \pm 0.02$	1.49
	5.82	1.771	0–5	7	$0.36 \pm 0.03$	6.11	0.58	8–20	4	$0.71 \pm 0.01$	1.23
	0.113							0–4	6	$4.27 \pm 0.10$	
	0.106	0.779	0.4–0.8	5	$0.38 \pm 0.11$	2.03	0.77	2.5–8.7	6	$(3.07 \pm 0.02)^a$	
	0.111	1.113	0–1.4	7	$0.24 \pm 0.03$			2.5–11.6	5	$4.00 \pm 0.16$	
	0.013							2.4–3.9	3	$14.59 \pm 0.23$	
	0.012							0.2–3.2	8	$14.77 \pm 0.67$	
0.012	0.389	0.3–1.3	6	$0.25 \pm 0.07$	1.42	0.55	1.4–1.9	2	13.48	24.63	
5.60	0.776						3–17	6	$0.60 \pm 0.03$		
MeOIH	5.62	1.113	0–0.5	4	$0.35 \pm 0.10$	5.37	0.41	7–17	6	$0.60 \pm 0.03$	1.46
	0.107	0.708	0–1	2	$(1.52 \pm 0.14)^a$	2.90	0.49	4–5	3	$6.52 \pm 0.09$	13.34
MeElH	5.88							2–18	9	$0.65 \pm 0.03$	
	5.79	1.113	0.5–3	6	$0.30 \pm 0.02$	5.24	0.43	5–17	7	$(0.34 \pm 0.01)^a$	$(0.8)^a$

<sup>a</sup> Values in parentheses are outliers when calculating mean  $G(\text{LOOH})$  or  $\nu$  but, nevertheless, are useful for determining  $D_{\text{inh}}$ .

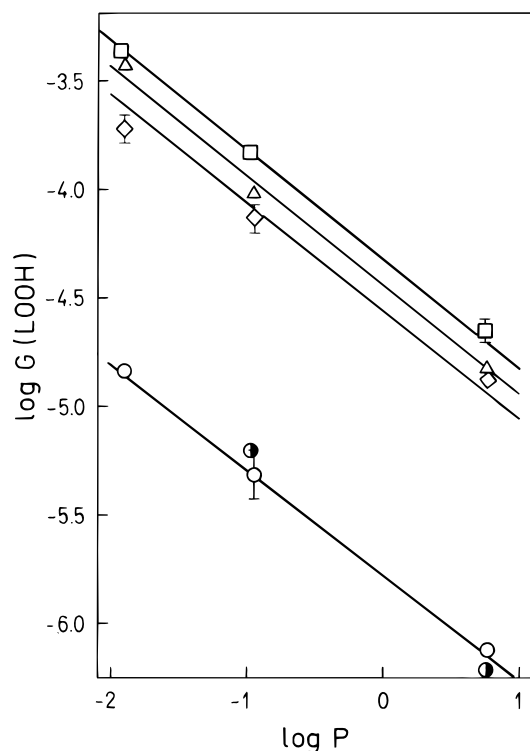

Figure 3. The effect of dose rate  $P$  (Gy/s) on radiation-chemical yields of LOOH in LHs bubbled with oxygen: (○) OIH; (●) methyl ester of OIH; (◇) LiH; (△) LinH; (□) ArH.

acids, Figure 5. This means that the same radiation-chemical yield of alkyl radical  $G(L^{\bullet}) = 0.52 \pm 0.16 \mu\text{mol}/\text{J}$  was obtained in all fatty acids (Figure 6).

The common value of  $G(L^{\bullet})$  was confirmed in Figure 7 which shows the dependence of  $G(\text{LOOH})_{\text{inh}}$  on the concentration ratio  $[\text{LH}]/[\alpha\text{-toc}]$  for LiH, LinH, and ArH in terms of eq 15a. The common intercept of the straight lines for LiH, LinH, and ArH in Figure 7, according to eq 15a, is  $G(L^{\bullet})\rho/2$ . The slopes of the straight lines give the ratio of the rate constants  $k_p/k_{\text{inh}}$ . Although the precision of measuring the low values of  $G(\text{LOOH})_{\text{inh}}$  was

poor, Figure 7 shows that the data fit eq 15a better than eq 25 (see below), which would require straight lines to start from the origin.

The expected value of  $k_p/k_{\text{inh}}$  for OIH is lower than that for any other LH so that the slope of the corresponding straight line for OIH in Figure 7 would be about 50 times smaller than that for LiH. The values of  $G(\text{LOOH})$  in the inhibited dose range for LiH, LinH, and ArH are already very low so that the reliability of the slopes determined by them is not very good. An even poorer reliability of OIH data prevented their inclusion in Figure 7.

The limiting values of  $G(\text{LOOH})$  in intermittent irradiations at very low rotation speed could not be determined directly. Namely, at the present combination of the effective dose rate and  $r$ , it would require very slow rotation, which, in turn, would require very long exposure times so that a statistically significant number of complete cycles could be accomplished. This would result in an unacceptably high and indistinguishable contribution of autoxidation to the radiation-induced peroxidation accrued during exposure.

However, the limiting values of  $G(\text{LOOH})$  at very low rotation speed could be calculated from the inverse square-root relationship of  $G(\text{LOOH})$  and dose rate, eq 24. The dose rate for this calculation would be the dose rate extant in the irradiating position, 0.3 Gy/s. In the same way, the limiting values of  $G(\text{LOOH})$  at very high rotation speed could be calculated as the ones which would be obtained at the effective dose rate, 0.021 Gy/s. The limiting values of  $G(\text{LOOH})$  at very low rotation speed could also be calculated from the experimentally obtained  $G(\text{LOOH})$  values at very high rotation speed divided by  $\sqrt{r+1}$ . All calculated and experimental values are found in Table 2. It can be seen that the experimental values obtained at very high rotation speed, and the values at very low rotation speed derived from the former by dividing with  $\sqrt{r+1}$ , were higher than the corresponding values calculated from eq 24. This excess of experimental over calculated values indicates the contribution of autoxidation due to an enhanced oxygenation, because the rotation of the samples on a slanted rotating wheel caused periodic increases of the surface of the liquid exposed to air. The effect was more pronounced in LHs with larger oxidizability; for OIH and LiH the calculated values

**TABLE 2: Radiation Chemical Yields of Fatty Acid Hydroperoxides in Steady-State Irradiation at  $P = 1$  Gy/s and in Intermittent Irradiation at High and Low Rotation Speed**

LH	steady-state irradiation		intermittent irradiation				$G_{\text{exp}}/G_{\text{calc}}$ (both at high and low speed)
	$G(\text{LOOH})_0$ [ $\mu\text{mol}/\text{J}$ ] calcd from eq 24	$a$	$G(\text{LOOH})_{\text{high speed}}$ [ $\mu\text{mol}/\text{J}$ ]		$G(\text{LOOH})_{\text{low speed}}$ [ $\mu\text{mol}/\text{J}$ ]		
			experimental (measured)	calcd from eq 24	experimental (measured/ $\sqrt{r+1}$ )	calcd from eq 24	
OIH	1.69	-0.47	$13.0 \pm 1.6$	11.6	3.4	3.1	1.12
MeElH	1.58	-0.50 <sup>a</sup>	$12.5 \pm 0.6$	10.8	3.3	2.9	1.14
LiH	28.8	-0.43	$225.2 \pm 7.7$	196.2	59.7	52.2	1.15
LinH	35.3	-0.51	$429.4 \pm 17.5$	240.5	113.9	64.0	1.79
ArH	50.5	-0.48	$670.8 \pm 11.9$	344.2	177.9	91.5	1.94

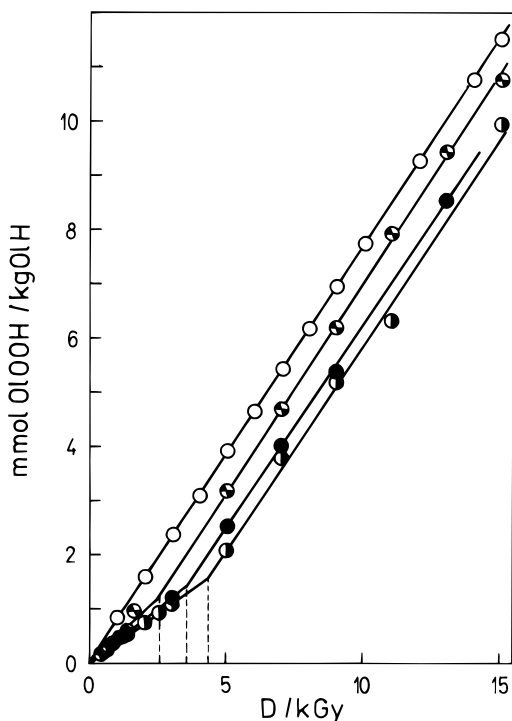
<sup>a</sup> Assumed.**Figure 4.** The effect of dose and  $\alpha$ -tocopherol on the accumulation of OIOOH in OIH irradiated at  $P = 6$  Gy/s and bubbled with oxygen. Straight lines in descending order correspond to the increasing amounts of  $\alpha$ -tocopherol: 0.0; 0.743; 0.885; 1.133 mmol  $\alpha$ -toc/kg OIH.

were higher by merely 12% and 15%, respectively, while for LinH and ArH the experimental values were 79% and 95% higher than the respective calculated values. It could not be distinguished from radiation-induced peroxidation in the analysis of the accumulation of LOOH with dose, because it was also apparently linear with time, at least up to 0.3 kGy (not shown), even at that early stage of oxidation. Fortunately, it is not critical, because it cancels out in the ratio  $G/G_{\text{max}}$  needed for the construction of Figure 8.

The values of  $\log \tau$  were determined as the differences given by eq 23a directly from Figure 8. The values of  $\tau$  were used to calculate  $k_{13}$  according to eq 22b, and this value, together with oxidizability obtained from eq 7c, was then used to calculate  $k_p$ . The values obtained are found in Table 3, together with the values of  $k_p/k_{\text{inh}}$  obtained from eq 15a and  $k_{\text{inh}}$  values calculated therefrom. The common value of  $k_{\text{inh}}$ ,  $(2.0 \pm 0.4) \times 10^5 \text{ dm}^3 \text{ mol}^{-1} \text{ s}^{-1}$ , obtained for the three PUFAs (LiH, LinH, and ArH) is a fine evidence of the internal consistency of this investigation.

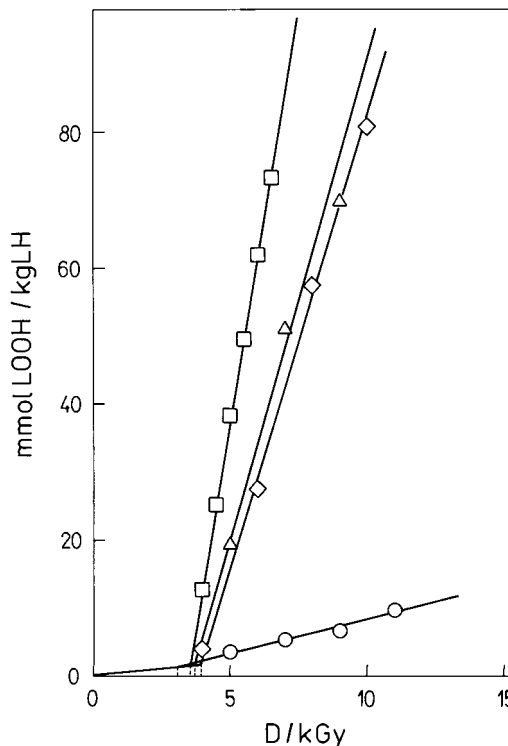
**Figure 5.** The (in)dependence of inhibition dose on the nature of LH irradiated at 6 Gy/s and bubbled with oxygen. Straight lines in order of decreasing slopes correspond to about the same concentration of  $\alpha$ -tocopherol: ( $\square$ ) 0.821 mmol  $\alpha$ -toc/kg ArH; ( $\triangle$ ) 0.754 mmol  $\alpha$ -toc/kg LinH; ( $\diamond$ ) 0.749 mmol  $\alpha$ -toc/kg LiH; ( $\circ$ ) 0.885 mmol  $\alpha$ -toc/kg OIH.

## Discussion

**The Effect of Dose Rate on Oxidizability.** The kinetics of peroxidation of LH in many previous studies was followed by continuous monitoring of oxygen uptake.<sup>4-8,12,27</sup> The application of this method required long chain lengths so that the evolution of oxygen in termination reaction 6 could be neglected. This requirement could most easily be met by minimizing the initiation rate, which was the only controllable parameter. In radiation-induced peroxidation, it can be conveniently achieved by reducing dose rate, because kinetic chain length is inversely proportional to the square root of dose rate.

Rather than monitoring oxygen consumption, the measurement of LOOH in the present work allowed a large span of dose rates to be used for initiation, including relatively high dose rates. At the highest dose rate used in this work, 6 Gy/s, the corresponding lowest radiation-chemical yield of hydroperoxides was about 0.8  $\mu\text{mol}/\text{J}$  in OIH, which gave  $\nu$  less than

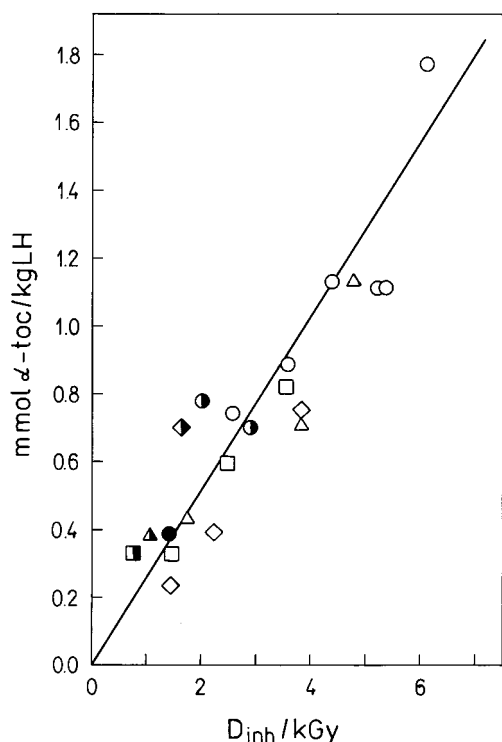

**Figure 6.** Inhibition dose as a function of the concentration of  $\alpha$ -tocopherol in LH: (○) OIH; (◇) LiH; (△) LinH; (□) ArH; (open symbols)  $P = 6$  Gy/s; (semi-filled symbols)  $P = 0.11$  Gy/s; (filled symbols)  $P = 0.012$  Gy/s. The positions of the independent variable (concentration of  $\alpha$ -toc) and that of the function (dose) are inverted, so that  $G(L^*)$  follows as the product  $n \times$  slope.

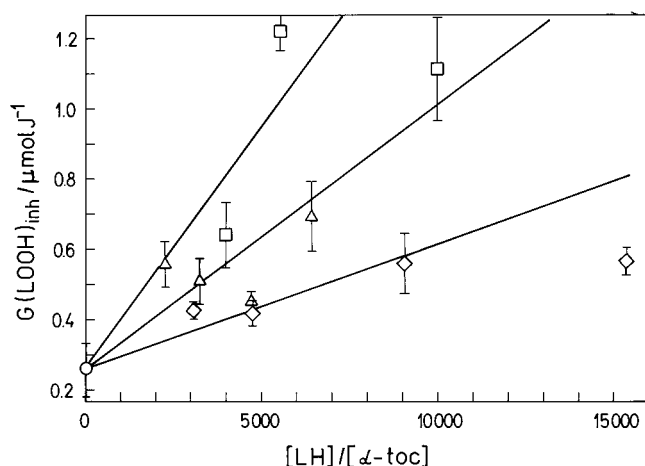

**Figure 7.** Inhibited radiation-chemical yield of LOOH as a function of the concentration ratio  $[LH]/[\alpha\text{-toc}]$  at  $P = 6$  Gy/s and bubbled with oxygen: (◇) LiH; (△) LinH; (□) ArH.

1.5. Nevertheless, the kinetic scheme was valid even at these extreme conditions, due to the method of monitoring peroxidation which was insensitive to the depletion of oxygen. At the same time, the longest kinetic chain length was about 830 (in ArH irradiated at 0.012 Gy/s).

Generally, lower dose rates were found to be more efficient in producing lipid hydroperoxidation in model membranes,<sup>9,28</sup> although no inverse square-root correlation with dose rate was originally tested in those systems. Our analysis of some of the published results in soybean bilayer liposomes<sup>29</sup> and egg lecithin bilayers<sup>16</sup> showed that the amount of radiation-chemical change was consistent with eq 24, but the exponent  $a$  was between  $-0.8$  and  $-0.9$  in the former and  $-0.8$  in the latter case. The mean value of  $a = -0.82 \pm 0.04$  was reported in phospholipid model

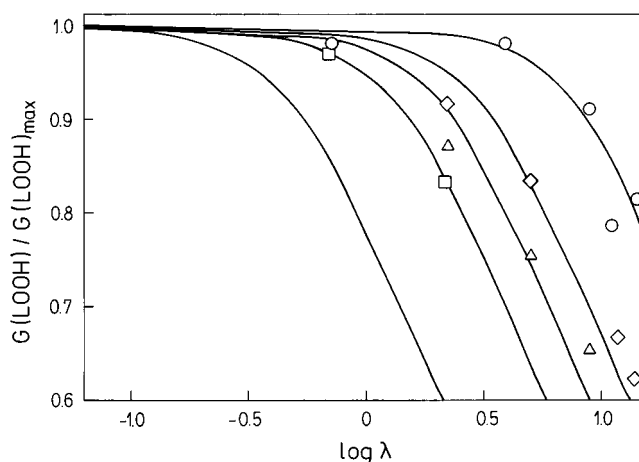

**Figure 8.** The effect of irradiation time  $\lambda$  in intermittent irradiation at the effective dose rate  $P = 0.021$  Gy/s and  $r = 13.22$  on relative radiation-chemical yields of LOOH in: (○) OIH; (◇) LiH; (△) LinH; (□) ArH.

membranes.<sup>30</sup> It would appear that dose rate dependence of peroxidation in microheterogeneous systems is closer to a simple inverse dose-rate relationship.

On the other hand, by taking different indicators as measures of peroxidation,<sup>14</sup> as well as by taking measurements at different times after irradiation,<sup>31</sup> different dose-response curves could be obtained, which may distort the results. However, studies in homogeneous systems<sup>6-8</sup> demonstrated the validity of the expected inverse square-root relationship with dose rate.

The rate of production of hydroperoxides is given by eq 7; when it is combined with the inverse square-root dependence of the radiation-chemical yield of LOOH (eq 24), the rate of production of LOOH is

$$d[\text{LOOH}]/dt = G_0(\text{LOOH})\rho\sqrt{P} \quad (7d)$$

For a given LH characterized by  $G_0(\text{LOOH})$ , the rate of peroxidation is proportional to the square root of dose rate.

The amount of LOOH produced in a specified time is

$$\Delta[\text{LOOH}] = G_0(\text{LOOH})\rho\sqrt{P}\Delta t \quad (7e)$$

that is, the largest oxidative change will occur in targets irradiated at the highest dose rate.

On the other hand, if the amount of hydroperoxides produced by a given dose ( $D = Pt$ ) is considered, the largest oxidative change to a given LH at a fixed  $D$  will occur in targets irradiated at the lowest dose rate.

$$\Delta[\text{LOOH}] = (G_0(\text{LOOH})\rho/\sqrt{P})\Delta D \quad (7f)$$

The effects of physical agents acting at some constant rate are often observed as a function of time, and the effects of ionizing radiations are not an exception. Intercomparisons of these effects are usually made on the basis of equal duration of exposures: for example, the extent of oxidative damage over a specified interval of time is proportional to  $\sqrt{P}$  (eq 7e). If, on the other hand, a somewhat higher than natural dose rate is applied, the comparison of effects observed at the same total dose, but received over different time intervals, becomes interesting. Under these conditions, eq 7f would apply.

Considerations along these lines gave rise to some concerns over the effects on the biosphere of the natural background radiation and of the increased levels thereof, ensuing as a



**TABLE 3: Absolute Rate Constants of Elementary Steps in Radiation-Induced Peroxidation of Unsaturated Fatty Acids**

LH	$k_p/\sqrt{2k_{t3}}$ [dm <sup>3/2</sup> mol <sup>-1/2</sup> s <sup>-1/2</sup> ]	$2k_{t3}$ [dm <sup>3</sup> mol <sup>-1</sup> s <sup>-1</sup> ]	$k_p$ [dm <sup>3</sup> mol <sup>-1</sup> s <sup>-1</sup> ]	$k_p/k_{inh}$	$k_{inh}$ [dm <sup>3</sup> mol <sup>-1</sup> s <sup>-1</sup> ]
OIH	$(6.9 \pm 0.9) \times 10^{-4}$	$(0.6 \pm 0.06) \times 10^6$	$0.56 \pm 0.03$		
MeOIH	$(6.9 \pm 1.0) \times 10^{-4}$	$(2.4 \pm 1.1) \times 10^6$	$1.07 \pm 0.16$		
LiH	$(1.2 \pm 0.2) \times 10^{-2}$	$(5.3 \pm 2.0) \times 10^6$	$26.9 \pm 4.8$	$(1.4 \pm 0.6) \times 10^{-4}$	$(1.9 \pm 0.9) \times 10^5$
LinH	$(1.4 \pm 0.2) \times 10^{-2}$	$(11.2 \pm 4.6) \times 10^6$	$47.6 \pm 9.7$	$(3.0 \pm 1.6) \times 10^{-4}$	$(1.6 \pm 0.9) \times 10^5$
ArH	$(2.2 \pm 0.2) \times 10^{-2}$	$(25.2 \pm 1.0) \times 10^6$	$110.9 \pm 2.2$	$(4.6 \pm 1.9) \times 10^{-4}$	$(2.4 \pm 1.0) \times 10^5$

**TABLE 4: Intercomparison of the Published Values of Oxidizability  $k_p/\sqrt{2k_{t3}}$  [dm<sup>3/2</sup> mol<sup>-1/2</sup> s<sup>-1/2</sup>] of Unsaturated Fatty Acids in Homogeneous Solutions**

reference	(21)	(33)	(34)	(35)	(36)	(37)	mean value	this work
initiator	ACHN <sup>a</sup>	BP <sup>b</sup>	AIBN <sup>c</sup>	AIBN <sup>c</sup>	AMPN <sup>d</sup> , AMVN <sup>e</sup>	AIBN <sup>c</sup>		<sup>60</sup> Co $\gamma$ -rays
temperature(K)	303	318	298	323	310	313		293
solvent	chlorobenzene	pure substrate	chlorobenzene	chlorobenzene	chlorobenzene	chlorobenzene		pure substrate
LH	MeOIH	MeOIH	MeOIH	EtOIH		MeOIH		OIH
measured value	$8.9 \times 10^{-4}$	$15.3 \times 10^{-4}$	$5.3 \times 10^{-4}$	$53 \times 10^{-4}$		$22 \times 10^{-4}$		$6.94 \times 10^{-4}$
corrected value <sup>f</sup>	$3.89 \times 10^{-4}$	$6.43 \times 10^{-4}$	$2.78 \times 10^{-4}$	$11.74 \times 10^{-4}$		$6.82 \times 10^{-4}$	$(6.33 \pm 3.47) \times 10^{-4}$	
relative value <sup>g</sup>	0.04	0.07	0.05	0.13		0.10	$0.08 \pm 0.04$	0.06
LH	MeLiH	EtLiH	MeLiH	EtLiH	MeLiH	MeLiH		LiH
measured value	$2.1 \times 10^{-2}$	$2.07 \times 10^{-2}$	$1.1 \times 10^{-2}$	$4.0 \times 10^{-2}$	$2.03 \times 10^{-2}$	$2.2 \times 10^{-2}$		$1.18 \times 10^{-2}$
corrected value <sup>f</sup>	$0.92 \times 10^{-2}$	$0.87 \times 10^{-2}$	$0.58 \times 10^{-2}$	$0.89 \times 10^{-2}$	$0.70 \times 10^{-2}$	$0.70 \times 10^{-2}$	$(0.78 \pm 0.14) \times 10^{-2}$	
relative value <sup>g</sup>	1.00	1.00	1.00	1.00	1.00	1.00	1.00	1.00
LH	MeLinH	EtLinH	MeLinH	MeLinH	EtLinH	MeLinH		LinH
measured value	$3.9 \times 10^{-2}$	$4.14 \times 10^{-2}$	$1.8 \times 10^{-2}$	$8.6 \times 10^{-2}$	$4.07 \times 10^{-2}$	$5.0 \times 10^{-2}$		$1.44 \times 10^{-2}$
corrected value <sup>f</sup>	$1.70 \times 10^{-2}$	$1.74 \times 10^{-2}$	$0.94 \times 10^{-2}$	$1.91 \times 10^{-2}$	$1.39 \times 10^{-2}$	$1.55 \times 10^{-2}$	$(1.54 \pm 0.34) \times 10^{-2}$	
relative value <sup>g</sup>	1.86	2.00	1.62	2.15	2.00	2.27	$1.98 \pm 0.23$	1.22
LH					EtArH			ArH
measured value					$5.75 \times 10^{-2}$			$2.21 \times 10^{-2}$
corrected value <sup>f</sup>					$1.97 \times 10^{-2}$			
relative value <sup>g</sup>					2.83			1.87

<sup>a</sup> ACHN, azobiscyclohexylnitrile. <sup>b</sup> BP, benzoyl peroxide. <sup>c</sup> AIBN, azobis-isobutyronitrile. <sup>d</sup> AMPN, azobis-methylpropionitrile. <sup>e</sup> AMVN, azobisdimethylvaleronitrile. <sup>f</sup> Measured values reduced to 293 K and nonpolar medium as described in the text. <sup>g</sup> Normalized within each literature reference taking oxidizability of LiH = 1.00.

consequence of human activities. However, the effects in living matter cannot be expected to depend exclusively on eq 7f; this equation would predict extremely large effects at extremely low dose rates, but these effects would require long times to express themselves. In the course of this long time, the repair mechanisms might set in to mitigate the ill effects on one hand, while, on the other hand, sheer aging might completely overwhelm the effects of irradiation on a very long time scale. In any case, a good knowledge of radiobiology and not only of physical-chemical phenomena, is critical in interpreting the effects of low dose-rate irradiation on living matter.

An inverse square-root relationship between  $G(\text{LOOH})$  values and dose rate was used to calculate  $G_0(\text{LOOH})$  values (Table 2). These may also be considered baseline values and can be compared with the available literature data.

However, radiation chemical yields of the corresponding hydroperoxides were measured only in OIH<sup>32</sup> and MeOIH<sup>6,32</sup> irradiated as neat liquids. High doses were used in both studies, taking oxidation up to 12%<sup>6</sup> and 40%,<sup>32</sup> respectively. While a good linearity of MeOIOOH formation with dose was observed up to 8%,<sup>6</sup> a strongly sublinear build-up was observed at higher conversions.<sup>32</sup> Tangents to the initial parts of the dose-buildup curves obtained at 0.33 and 1.18 Gy/s gave the values of  $G(\text{OIOOH}) = 10.94$  and  $6.45 \mu\text{mol/J}$ , respectively.<sup>32</sup> The application of eq 24 gave  $a = -0.41$  and  $G_0(\text{OIOOH}) = 6.92 \mu\text{mol/J}$ , which is too high, probably because of impurities. The other study<sup>6</sup> gave  $G_0(\text{MeOIOOH}) = 0.85 \mu\text{mol/J}$ , which compares better to our  $G_0(\text{OIOOH}) = 1.69 \mu\text{mol/J}$ , but nevertheless, shows that large discrepancies between unrelated groups of experiments are possible.

**The Effects of Temperature and Solvent Polarity on Oxidizabilities of LH.** An attempt to compare the results of this work with the available literature data on oxidizability of

bulk LH or their homogeneous solutions in chlorobenzene is made in Table 4. For this purpose, the literature data were subject to some scaling with respect to temperature and solvent polarity effects. In an attempt to establish baseline values of oxidizability, a temperature of 20 °C and polarity corresponding to pure substrate were adopted as standard conditions.

The effect of temperature on oxidizability was taken into account by assuming the activation energy of oxidizability,  $(E_p - 0.5E_{t3})_{\text{LH}} = 27.6 \text{ kJ/mol}$ . This value is the mean of  $(E_p - 0.5E_{t3})_{\text{MeOIH}} = 29.5 \text{ kJ/mol}$  and  $(E_p - 0.5E_{t3})_{\text{EtLiH}} = 25.6 \text{ kJ/mol}$ , as calculated from the data by Bateman<sup>33</sup> at 45 and 55 °C, and is also very close to  $(E_p - 0.5E_{t3})_{\text{MeOIH}} = 26.8 \text{ kJ/mol}$ , reported by Hyde and Verdin.<sup>6</sup>

The effect of solvent polarity was accounted for by dividing oxidizability in chlorobenzene solutions by 1.58, which is the oxidation rate of MeLiH at 50 °C in this solvent, relative to the oxidation rate in carbon tetrachloride<sup>3</sup>, which has a dielectric constant similar to that of fatty acids.<sup>38</sup> There was no need to make correction for the change of dielectric constant with temperature, or for the change of the relative reactivity with temperature. Esterification does not influence the reactivity, because the effect of polarity, which would be expected on the basis of the larger dielectric constant of esters, as compared to free acids,<sup>38</sup> is rather small.

Although, strictly speaking, the adopted corrections apply only to MeOIH and MeLiH/EtLiH, the corrected values for all LH in Table 4 agree much better among themselves than the scattered original values obtained under a variety of experimental conditions. Apparently, very similar activation energies, as well as a similar acceleration of autoxidation rates with the solvent polarity, apply to all LH. Actually, the agreement is so good that it is tempting to calculate the means of the corrected values. The relative error of the mean for any particular LH is typically

**TABLE 5: Intercomparison of the Published Values of Propagation and Termination Rate Constants in the Autoxidation of LiH in Homogeneous Solutions**

reference	(21)				this work	
initiator	ACHN <sup>a</sup>				<sup>60</sup> Co $\gamma$ -rays	
temperature (K)	303				293	
solvent	chlorobenzene				pure substrate	
measured quantity	$k_p$	$2k_{t3}$	$k_p/\sqrt{2k_{t3}}$	$k_p$	$2k_{t3}$	$k_p/\sqrt{2k_{t3}}$
	[dm <sup>3</sup> mol <sup>-1</sup> s <sup>-1</sup> ]	[dm <sup>3</sup> mol <sup>-1</sup> s <sup>-1</sup> ]	[dm <sup>3/2</sup> mol <sup>-1/2</sup> s <sup>-1/2</sup> ]	[dm <sup>3</sup> mol <sup>-1</sup> s <sup>-1</sup> ]	[dm <sup>3</sup> mol <sup>-1</sup> s <sup>-1</sup> ]	[dm <sup>3/2</sup> mol <sup>-1/2</sup> s <sup>-1/2</sup> ]
LH		MeOIH			OIH	
measured values	0.92 <sup>b</sup>	$1.06 \times 10^6$	$8.9 \times 10^{-4}$	0.56	$0.64 \times 10^6$	$6.94 \times 10^{-4}$
corrected values <sup>d</sup>	0.35	$0.81 \times 10^6$	$3.89 \times 10^{-4}$			
LH		MeLiH			LiH	
measured values	62	$8.8 \times 10^6$	$2.1 \times 10^{-2}$	26.9	$5.3 \times 10^6$	$1.18 \times 10^{-2}$
corrected values <sup>d</sup>	23.5	$6.71 \times 10^6$	$0.92 \times 10^{-2}$			
LH		MeLinH <sup>c</sup>			LinH	
measured values	236	$36 \times 10^6$	$3.9 \times 10^{-2}$	47.6	$11.2 \times 10^6$	$1.44 \times 10^{-2}$
corrected values <sup>d</sup>	89.6	$27.43 \times 10^6$	$1.70 \times 10^{-2}$			
LH					ArH	
measured values				110.9	$25.2 \times 10^6$	$2.21 \times 10^{-2}$

<sup>a</sup> ACHN, azobiscyclohexylnitrile. <sup>b</sup> This value was given as 0.22 in the original paper<sup>21</sup> and subsequently corrected in a later review.<sup>39</sup> <sup>c</sup> Because of experimental difficulties, the authors claim these data much less reliable in comparison with the others, which are claimed to be accurate to within a factor of 2 (for  $k_{t3}$ ) and 50% (for  $k_p$ ), respectively. <sup>d</sup> Measured values reduced to 293 K and nonpolar medium as described in the text.

only about 20%. At the same time, our values lie typically within 10% of thus calculated means of the corrected literature values.

However, LiH is somewhat exceptional, our value being ~50% higher, and that deserves a comment, because LiH has been used to normalize oxidizability values for other LHs.<sup>36</sup> One explanation might be that some previous workers, in the expectation that the increase of relative oxidizabilities should linearly follow the increase of the number of methylenic carbons in the molecule, were inclined to adopt unrealistically low values for  $k_p/\sqrt{2k_{t3}}$  in LiH. Indeed, in an isolated later determination the value of  $k_p/\sqrt{2k_{t3}}$  was found as  $(1.84 \pm 0.20) \times 10^{-2} \text{ dm}^{3/2} \text{ mol}^{-1/2} \text{ s}^{-1/2}$  at 310 K in neat MeLiH.<sup>40</sup> The extrapolation to 293 K gives a value of  $(1.00 \pm 0.11) \times 10^{-2} \text{ dm}^{3/2} \text{ mol}^{-1/2} \text{ s}^{-1/2}$ , in a better agreement with our determination.

If all absorbed energy were utilized to produce only free radicals L<sup>•</sup>, the energy required to break the weakest bisallylic carbon–hydrogen bond (314 kJ/mol)<sup>1</sup> would suffice to produce  $(0.52 \times 10^{-6} \text{ mol L}^{-1} \text{ J}^{-1}) \times (314 \times 10^3 \text{ J/mol } -\text{CH}_2-) = 0.16 \text{ mol L}^{-1} \text{ mol } -\text{CH}_2-$ , or one radical per six methylenic carbons. In linoleic acid this would mean that one out of six affected molecules would yield a free radical Li<sup>•</sup>. Consequently, in LinH this would make one out of three and in ArH one out of two molecules, respectively, yielding the corresponding free radicals.

Our relative oxidizability data indicate that, as far as the formation of peroxy radicals is concerned, this kind of proportionality is not carried over to higher PUFA. Relative oxidizability in LinH, 1.22, gives  $0.16 \times 1.22 = 0.20$ , or that only one out of five (and not three) molecules yields LinOOH, while in ArH this happens with only one out of three (instead of two) molecules. In reality, these probabilities are even less frequent, because absorbed radiation energy is nonselectively used to produce also other smaller fragments in irradiated fatty acids.

It is possible that relatively large systematic errors in individual rate constants become partially compensated in oxidizability, which is a ratio of these rate constants. A criterion of acceptability of a quantity expressed as a ratio should include the evaluation of individual reaction steps. Consequently, in Table 5 we compare the individual rate constants of elementary reaction steps obtained in this work with the only set of the corresponding values available in the literature.<sup>21</sup> The literature data were corrected for the effects of temperature and solvent polarity, as already described above.

While the correction for the temperature effect on oxidizability was based on the estimated activation energy as already mentioned,  $(E_p - 0.5E_{t3})_{\text{LH}} = 27.6 \text{ kJ/mol}$ , activation energy for the termination step was 20.1 kJ/mol, obtained in 0.1 mM aqueous solution of OH adduct to LiH.<sup>8</sup> Activation energy for the propagation step was calculated therefrom as 37.7 kJ/mol. The correction for the effect of solvent polarity was applied to  $k_p$  values only, in keeping with the opinion that changes of oxidizability reflect changes in  $k_p$ , with  $k_{t3}$  remaining essentially constant.<sup>20</sup>

Table 5 shows that the agreement between the only two sets of data in nearly complete homologous series of LH is rather good for this type of measurements, for the declared reliability of the literature data<sup>21</sup> and for the scatter of our own measurements (Table 2). The largest discrepancies between the values, as long as the individual rate constants are concerned, are revealed now for linolenic acid; it is not surprising in view of the fact that previous measurements for LinH were maintained to be much less reliable than for most other compounds, for which (those other compounds) an accuracy to within a factor of 2 for  $k_{t3}$ , and 50% for  $k_p$ , respectively, were claimed.<sup>21</sup>

The increase of oxidizability in the homologous series of LH, which is consistent with the similar increase of reactivity of LHs toward selective free radicals<sup>41</sup> and consistent with the moderate selectivity of fatty acid peroxy free radical (BDE-(LOO-H)  $\approx 377 \text{ kJ/mol}$ <sup>42</sup>), is beyond all question. It just may not be so regularly linear, about  $2 \times 10^{-2} \text{ dm}^{3/2} \text{ mol}^{-1/2} \text{ s}^{-1/2}$  per methylenic carbon, as proposed.<sup>36</sup>

Our data suggest a somewhat different type of regularity within the homologous series of LH, which was somewhat longer in the present study. The individual rate constants, both  $k_p$  and  $k_{t3}$ , double as the number of bisallylic carbons increases from 1 to 2 to 3. Expressed in terms of oxidizabilities relative to LiH, the series would consist of the following values: 1,  $\sqrt{2}$ , 2,  $2\sqrt{2}$ , 4,  $4\sqrt{2}$ , etc.

Relative oxidizabilities pertaining to ArH and docosahexaenoic acid, as predicted by our series, would be 2 and 4, respectively, while the relative values obtained by Cosgrove et al. were 2.83 and 5.00, respectively.<sup>36</sup> However, the normalization of their results to their own more recent value of 1.84 for MeLiH,<sup>40</sup> (1.00 after our correction for the temperature effect) gives relative oxidizabilities of 2 and 3.47 for ArH and docosahexaenoic acid, respectively.

**TABLE 6: Intercomparison of the Published Values of Inhibition Rate Constants  $k_{\text{inh}}$  for  $\alpha$ -Tocopherol in the Autoxidation of LH in Homogeneous Solutions**

oxidizing radical LOO $\cdot$	solvent	$\epsilon$	$T$ [K]	authors' values at $T$ [K]				based on our values at $T$ [K]	
				$(k_p/k_{\text{inh}}) \times 10^4$	$k_p$ (lit) [dm $^3$ mol $^{-1}$ s $^{-1}$ ]	$k_{\text{inh}} \times 10^{-5}$ [dm $^3$ mol $^{-1}$ s $^{-1}$ ]	ref	$k_p$ [dm $^3$ mol $^{-1}$ s $^{-1}$ ]	$k_{\text{inh}} \times 10^{-5}$ [dm $^3$ mol $^{-1}$ s $^{-1}$ ]
MeLiOO $\cdot$	C $_6$ H $_6$	2.3	310	2.0	<i>a</i>		(51)	48	2.4
MeOIOO $\cdot$	pure substrate	2.4 <sup>b</sup>	333	3.2	2.2 (deduced by us)	0.7	(52)	3.6	1.1
LiOO $\cdot$	pure substrate	2.7	293	1.4	26.9 (measured)	1.9	this work		
LinOO $\cdot$	pure substrate	2.8	293	3.0	47.6 (measured)	1.6	this work		
ArOO $\cdot$	pure substrate	2.8 <sup>b</sup>	293	4.6	110.9 (measured)	2.4	this work		
MeLiOO $\cdot$	PhCl	5.6	323	0.91	120 (21,53)	13.2	(37)	72	7.9
MeLinOO $\cdot$	PhCl	5.6	323	5.6	620 (?)	11.1	(37)	127	2.3
LiOO $\cdot$	<i>t</i> -BuOH	11	303	3.6	81.5 (measured)	2.3	(50)	33	0.9
MeLiOO $\cdot$	<i>t</i> -BuOH	11	310	2.0	100 (3,21)	5.1	(27)	46	2.3
MeLinOO $\cdot$	C $_7$ H $_{15}$ OH	11.4 <sup>c</sup>	353	0.17	1700 (assumed)	10	(55)	661	3.9
MeLinOO $\cdot$	C $_6$ H $_{13}$ COOEt	12 <sup>b</sup>	353	0.37	1470 (assumed)	4	(55)	661	1.8
MeLiOO $\cdot$	MeOH/ <i>t</i> -BuOH	22	310	0.91	100 (27)	11	(56)	27	2.9
LiOO $\cdot$	MeOH	33	310	2.0	100 (27)	4.9	(57)	21	1.1
MeLiOO $\cdot$	MeOH	33	310	3.1	100 (27)	3.2	(58)	21	0.7

<sup>a</sup> No value originally given by the authors. <sup>b</sup> Our estimate. <sup>c</sup> Reference 54.

**Inhibition by  $\alpha$ -Tocopherol.** Fatty acids are entirely devoid of any characteristic optical properties in the UV/vis regions of the spectrum. On the other hand, both  $\alpha$ -toc<sup>43</sup> and  $\alpha$ -tocopheroxyl radical<sup>44</sup> show a pronounced optical absorption. These properties, including fluorescence of  $\alpha$ -toc,<sup>45</sup> have been used to follow the kinetics of reactions between  $\alpha$ -toc and ethoxyl radicals,<sup>46</sup>  $\alpha$ -toc and ascorbic acid radical,<sup>47</sup> as well as of reactions between tocopheroxyl radicals with fatty acids.<sup>48</sup>

The reaction kinetics of the chain-breaking action of  $\alpha$ -toc has not been measured directly, presumably because a fast growth of strongly absorbing conjugated dienoic hydroperoxides, formed by the addition of oxygen to PUFA free radicals, would preclude the observation of the decaying  $\alpha$ -toc absorption. According to our knowledge, there has been only one rate constant reported in the literature, that for the reaction of  $\alpha$ -toc with oleic acid peroxy radical (which is free of the conjugation problems), measured by pulse radiolysis in neat oleic acid.<sup>43</sup> However, the growth of the optical absorption of  $\alpha$ -tocopheroxyl radical at 420 nm was used recently to measure the kinetics of hydrogen atom abstraction from  $\alpha$ -toc by cumylperoxy radicals,<sup>49</sup> and the same approach could be used with PUFA peroxy radicals, but such study has not yet been done.

All other values found in the literature are thus based on measurements of the rates of inhibited peroxidation  $R_{\text{inh}}$ , for which the following expression, similar to our expression 15a, was used:

$$R_{\text{inh}} = k_p[\text{LH}]R_i/nk_{\text{inh}}[\text{AH}] \quad (25)$$

where  $R_i$  denotes the initiation rate. The use of this expression requires the knowledge of  $k_p$ , and this quantity has not been determined each time  $k_{\text{inh}}$  was reported. In fact, most values of  $k_p$  needed for this calculation were adopted from the literature. Only Barclay et al. reported an independent measurement of  $k_p$  for LiOO $\cdot$  in *t*-BuOH.<sup>50</sup>

Until the present work, there have been no measurements of  $k_{\text{inh}}$  in the homologous series of PUFA in the homogeneous lipid phase. There have been, however, isolated measurements with individual unsaturated fatty acids, mostly often LiH, in various solvents. Available literature data are collected in Table 6 for comparison with our results. Reference is given to each author's source of  $k_p$ .

Generally, the assumptions of various authors regarding  $k_p$  are usually overestimates. As a consequence, their values of  $k_{\text{inh}}$  are also overestimated. Our values for  $k_p$  in Table 6 at the

temperature of each individual measurement are based on our measurements of  $k_p$  at 293 K for a given LH, scaled accordingly, assuming  $E_p = 37.7$  kJ/mol, and corrected for the solvent polarity according to Yamamoto et al.<sup>3</sup>, as already described. Although  $k_{\text{inh}}$  also depends on the polarity of the medium,<sup>59</sup> the paucity of the presently available data does not allow an appropriate correction to be made for this effect. Consequently, the resulting values of  $k_{\text{inh}}$  are valid for the temperature at which  $k_p/k_{\text{inh}}$  was originally measured, while the effect of solvent polarity is neglected in the present consideration, and all  $k_{\text{inh}}$  values are assumed to be related to the nonpolar, lipid-like phase.

With temperature thus remaining the only variable, it should be possible to present the resulting  $k_{\text{inh}}$  values in the Arrhenius fashion. As minor structural details of oxidizing radicals do not seem to influence  $k_{\text{inh}}$  significantly,<sup>60</sup> it is justified to treat all data without regard to the identity of various LHs and their esters. If one obviously outlying piece of data (MeLiOO $\cdot$  in chlorobenzene<sup>37</sup>) is disregarded, least-squares linear regression treatment of the remaining 10 literature values, together with the three ones obtained in this work, gives (Figure 9)

$$\ln k_{\text{inh}} = (13.8 \pm 2.4) - (536.3 \pm 740.8)/T \quad (26)$$

The Arrhenius activation energy following from this equation is 4.5 kJ/mol, and the pre-exponential factor is  $10^{6\pm 1}$ . These activation parameters, however, should be considered tentative until solvent polarity effects on  $k_{\text{inh}}$  can be taken into account properly. Nevertheless, the inhibition rate constant calculated at 293 K (excluding the data obtained in this work),  $1.2 \times 10^5$  dm $^3$  mol $^{-1}$  s $^{-1}$  is in a reasonable agreement with the mean of our values for the three PUFAs,  $(2.0 \pm 0.4) \times 10^5$  dm $^3$  mol $^{-1}$  s $^{-1}$ , indicating that no grave error has been committed by the neglect of the solvent polarity effect on  $k_{\text{inh}}$ .

Moreover, it also means that mechanistic considerations which follow and which are based on the analysis of provisional data may also be tentative but are at least qualitatively correct.

The obtained activation energy is below the activation energy for diffusion in nonviscous liquids,<sup>61</sup> while the rate constant  $k_{\text{inh}}$  is several orders of magnitude lower than the values corresponding to diffusion-controlled reactions.<sup>62</sup> Evidently, the rate constant  $k_{\text{inh}}$  is not affected by the temperature dependence of the diffusion rate.

Antioxidant activity of  $\alpha$ -toc has been interpreted in terms of hydrogen atom transfer,<sup>63</sup> electron transfer,<sup>64</sup> or a dual mechanism,<sup>65</sup> in which one mode would predominate over the

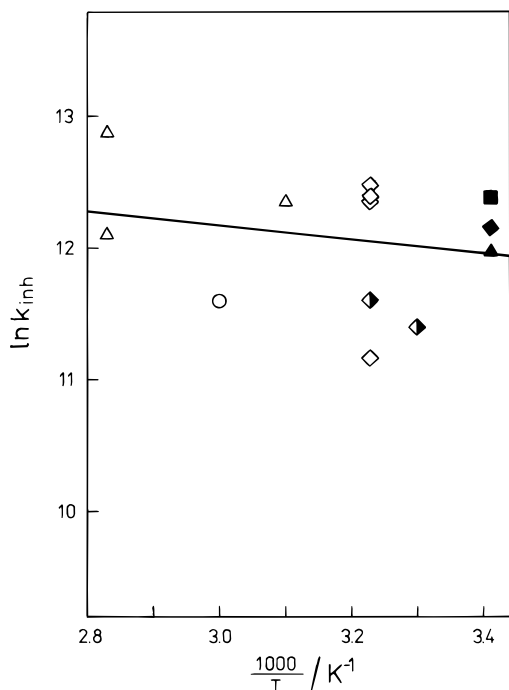

**Figure 9.** Arrhenius plot for the reaction of  $\text{LOO}^{\bullet}$  with  $\alpha$ -toc in pure lipid moiety (data from Table 6; the outlying value for MeLiH at 323 K was omitted): (○) OIH; (◇) LiH; (△) LinH; (□) ArH; (semi-filled symbols) free fatty acids (literature values); (open symbols) methyl esters (literature values); (filled symbols) free fatty acids (this work).

other, depending on the reactive species and the medium. It was suggested that electron transfer would be a dominant mechanism in polar solvents, whereas hydrogen atom transfer would dominate in nonpolar media.<sup>66</sup> According to this thinking, hydrogen atom transfer would be expected to dominate in neat fatty acids.

Activation parameters found by us, however, seem to contradict this conjecture. Small activation enthalpy indicates an entropy control, and a large negative entropy ( $\Delta S = -138$  J/mol K) was considered characteristic of an electron transfer in polar media, whereby polar solvent molecules participated in the transition state and a pronounced reorganization of the solvent shell was implied.<sup>66</sup> Furthermore, the pre-exponential factor is much lower than  $10^{10} \text{ dm}^3 \text{ mol}^{-1} \text{ s}^{-1}$ , the value characteristic for hydrogen atom transfer,<sup>67</sup> but corresponds to pre-exponential factors encountered in proton-transfer reactions from aliphatic alcohols to aromatic anions.<sup>68</sup> These findings would lend support to the mechanism of  $\alpha$ -toc action proposed by Nagaoka et al., whereby both charge and proton transfer occur.<sup>69</sup>

### Concluding Remarks

We have shown that initiation by irradiation can be used to study the kinetics of peroxidation of neat unsaturated fatty acids. There is a complete parallelism between autoxidation and radiation-induced peroxidation; rate of autoxidation corresponds to radiation-chemical yield of hydroperoxides, rate of initiation to the product of the radiation-chemical yield of alkyl free radicals and dose rate, and inhibition time to inhibition dose.

Quantitative knowledge of the kinetics of peroxidation of unsaturated fatty acids was based for a long time on a single set of measurements of elementary reaction steps in an incomplete homologous series of LH. The present work has provided a broader basis for comparison with that previous set, as well as with a number of isolated measurements on individual

LHs. Somewhat extended homologous series of LH and intercomparison with the literature values in this work made it possible to establish a new regularity of increasing oxidizability with the increasing number of bisallylic carbons in the series LiH/LinH/ArH/DPA/DHA as  $1:\sqrt{2}:2:2\sqrt{2}:4$ .

Corrections made for solvent effects on the literature values of the ratio  $k_p/k_{inh}$  obtained at various temperatures, together with our measurements of the same quantity in pure lipid phase, as well as the corrections of  $k_p$  for solvent polarity effects, enabled the study of the temperature effect on the rate constant of the inhibition reaction. Activation parameters of this reaction indicate an activation energy less than that for diffusion and an entropy control of the reaction, with the pre-exponential factor  $10^6$  characteristic of the proton-transfer reactions. These findings lend support to the view that both charge and proton-transfer mechanisms in the inhibition by  $\alpha$ -toc may be operative in the lipid moiety.

**Acknowledgment.** Skillful technical assistance of Mrs. M. Rajković and Mr. S. Štoković is gratefully acknowledged.

### References and Notes

- (1) Egger, K. W.; Cocks, A. T. *Helv. Chim. Acta* **1973**, *56*, 1516.
- (2) Hasegawa, K.; Patterson, L. K. *Photochem. Photobiol.* **1978**, *28*, 817.
- (3) Yamamoto, Y.; Niki, E.; Kamiya, Y. *Lipids* **1982**, *17*, 870.
- (4) Barclay, L. R. C. *Can. J. Chem.* **1993**, *71*, 1 and references therein.
- (5) Yamamoto, Y.; Niki, E.; Eguchi, J.; Kamiya, Y.; Shimasaki, H. *Biochim. Biophys. Acta* **1985**, *819*, 29.
- (6) Hyde, S. M.; Verdin, D. *Trans. Faraday Soc.* **1968**, *64*, 144.
- (7) Metwally, M. M. K.; Moore, J. S. *Int. J. Radiat. Biol.* **1987**, *52*, 253.
- (8) AlSheikhly, M.; Simic, M. G. *J. Phys. Chem.* **1989**, *93*, 3103.
- (9) Raleigh, J. A.; Kremers, W.; Gaboury, B. *Int. J. Radiat. Biol.* **1977**, *31*, 203.
- (10) Yau, T. M.; Mencl, J. *Int. J. Radiat. Biol.* **1981**, *40*, 47.
- (11) O'Connell, M. J.; Garner, A. *Int. J. Radiat. Biol.* **1983**, *44*, 615.
- (12) Hicks, M.; Gebicki, J. *Int. J. Radiat. Biol.* **1993**, *64*, 143.
- (13) Purohit, S. C.; Bisby, R. H.; Cundall, R. B. *Int. J. Radiat. Biol.* **1980**, *38*, 159.
- (14) Chatterjee, S. N.; Agarwal, S. *Free Radical Biol. Med.* **1988**, *4*, 51.
- (15) Chipault, J. R. In *Lipids and Their Oxidation*; Schultz, H. W., Day, E. A., Sinnhuber, R. O., Eds.; AVI Publishing Co.: Westport, CT, 1962; p 151.
- (16) Raleigh, J. A. In *Prostaglandins and Lipid Metabolism in Radiation Injury*; Walden, T. L., Jr., Hughes, H. N., Eds.; Plenum Press: New York, 1987; p 3.
- (17) Esterbauer, H. In *Free Radicals, Lipid Peroxidation and Cancer*; McBrien, D. C. H., Slater, T. F., Eds.; Academic Press: London, 1982; p 101.
- (18) Abuja, P. M.; Esterbauer, H. *Chem. Res. Toxicol.* **1995**, *8*, 753.
- (19) Antunes, F.; Salvador, A.; Marinho, H. S.; Alves, R.; Pinto, R. E. *Free Radical Biol. Med.* **1996**, *21*, 917.
- (20) Bateman, L.; Gee, G.; Morris, A. L.; Watson, W. F. *Discuss. Faraday Soc.* **1951**, *10*, 250.
- (21) Howard, J. A.; Ingold, K. U. *Can. J. Chem.* **1967**, *45*, 793.
- (22) Barclay, L. R. C.; Baskin, K. A.; Locke, S. J.; Vinquist, M. R. *Can. J. Chem.* **1989**, *67*, 1366.
- (23) Mihaljević, B.; Katušin-Ražem, B.; Ražem, D. *Free Radical Biol. Med.* **1996**, *21*, 53.
- (24) Bolland, J. L. *Proc. R. Soc.* **1946**, *A186*, 218.
- (25) Burnett, G. M.; Melville, H. W. In *Investigation of Rates and Mechanisms of Reactions, Part II*, 2nd ed.; Friess, S. L., Lewis, E. S., Weissberger, A., Eds.; Interscience: New York, 1963; p 1107.
- (26) Ražem, D.; Anđelić, L.; Dvornik, I. In *High-dose Dosimetry*; Proc. IAEA Symp., Vienna, 1984. International Atomic Energy Agency: Vienna, 1985; p 143.
- (27) Niki, E.; Saito, T.; Kawakami, A.; Kamiya, Y. *J. Biol. Chem.* **1984**, *259*, 4177.
- (28) Petkau, A. *Health Phys.* **1972**, *22*, 239.
- (29) Petkau, A.; Chelack, W. S. *Biochim. Biophys. Acta* **1976**, *433*, 445.
- (30) Petkau, A. *Acta Physiol. Scand.* **1980**, Suppl. 492, 81.
- (31) Corliss, G. A.; Dugan, L. R., Jr. *Lipids* **1970**, *5*, 846.
- (32) Dugan, L. R., Jr.; Landis, P. W. *J. Am. Oil Chem. Soc.* **1956**, *33*, 152.

- (33) Bateman, L. *Quart. Rev.* **1954**, *8*, 147.
- (34) Yanishlieva, N.; Skibida, I.; Maizus, Z.; Popov, A. *Izv. Otd. Khim. Nauk Bolg. Akad. Nauk* **1971**, *4*, 1 (in Russian).
- (35) Ushkalova, V. N. *Kinet. Katal.* **1984**, *25*, 283 (in Russian).
- (36) Cosgrove, J. P.; Church, D. F.; Pryor, W. A. *Lipids* **1987**, *22*, 299.
- (37) Roginskii, V. A. *Kinet. Katal.* **1990**, *31*, 546 (in Russian).
- (38) Larsson, K. In *The Lipid Handbook*; Gunstone, F. D., Harwood, J. L., Padley, F. B., Eds.; Chapman and Hall: London, 1986; p 321.
- (39) Howard, J. A. In *Advances in Free Radical Chemistry*; Williams, G. H., Ed.; Logos Press: London, 1972; Vol. IV, p 49.
- (40) Ewing, J. C.; Cosgrove, J. P.; Giamalva, D. H.; Church, D. F.; Pryor, W. A. *Lipids* **1989**, *24*, 609.
- (41) Bors, W. In *Free Radicals, Lipoproteins, and Membrane Lipids*; Crastes de Paulet, A., Douste-Blazy, L., Paoletti, R., Eds.; Plenum Press: New York, 1990; p 1.
- (42) Nangia, P. S.; Benson, S. W. *J. Phys. Chem.* **1979**, *83*, 1138.
- (43) Simic, M. G. In *Autoxidation in Food and Biological Systems*; Simic, M. G., Karel, M., Eds.; Plenum Press: New York, 1980; p 17.
- (44) Bisby, R. H.; Parker, A. W. *Arch. Biochem. Biophys.* **1995**, *317*, 170.
- (45) Kagan, V. E.; Serbinova, E. A.; Bakalova, R. A.; Stoytchev, Ts. S.; Erin, A. N.; Prilipko, L. L.; Evstigneeva, R. P. *Biochem. Pharmacol.* **1990**, *40*, 2403.
- (46) Jore, D.; Patterson, L. K.; Ferradini, C. *J. Free Radical Biol. Med.* **1986**, *2*, 405.
- (47) Kaouadji, M. N.; Jore, D.; Ferradini, C.; Patterson, L. K. *Bioelectrochem. Bioenerg.* **1987**, *18*, 59.
- (48) Mukai, K.; Morimoto, H.; Okauchi, Y.; Nagaoka, S. *Lipids* **1993**, *28*, 753.
- (49) Valgimigli, L.; Banks, J. T.; Luszyk, J.; Ingold, K. U. *J. Org. Chem.* **1999**, *64*, 3389.
- (50) Barclay, L. R. C.; Baskin, K. A.; Locke, S. J.; Schaefer, T. D. *Can. J. Chem.* **1987**, *65*, 2529.
- (51) Niki, E.; Komuro, E. In *Oxygen Radicals in Biology and Medicine*; Simic, M. G., Taylor, K. A., Ward, J. F., von Sonntag, C., Eds.; Plenum Press: New York, 1988; p 561.
- (52) Ushkalova, V. N.; Kadochnikova, G. D. *Kinet. Katal.* **1984**, *25*, 794 (in Russian).
- (53) Barclay, L. R. C.; Locke, S. J.; MacNeil, J. M.; van Kessel, J. *Can. J. Chem.* **1985**, *63*, 2633.
- (54) Fragata, M.; Bellemare, F. *J. Colloid Interface Sci.* **1985**, *107*, 553.
- (55) Rousseau-Richard, C.; Richard, C.; Martin, R. *J. Chim. Phys.* **1988**, *85*, 175.
- (56) Iuliano, L.; Pedersen, J. Z.; Rotilio, G.; Ferro, D.; Violi, F. *Free Radical Biol. Med.* **1995**, *18*, 239.
- (57) Braughler, J. M.; Pregoner, J. F. *Free Radical Biol. Med.* **1989**, *7*, 125.
- (58) Tesoriere, L.; Ciaccio, M.; Bongiorno, A.; Riccio, A.; Pintaudi, A. M.; Livrea, M. A. *Arch. Biochem. Biophys.* **1993**, *307*, 217.
- (59) Valgimigli, L.; Ingold, K. U.; Luszyk, J. *J. Am. Chem. Soc.* **1996**, *118*, 3545.
- (60) Burton, G. W.; Ingold, K. U. *J. Am. Chem. Soc.* **1981**, *103*, 6472.
- (61) Beckwith, A. L. J.; Bowry, V. W.; Ingold, K. U. *J. Am. Chem. Soc.* **1992**, *114*, 4983.
- (62) Foti, M.; Ingold, K. U.; Luszyk, J. *J. Am. Chem. Soc.* **1994**, *116*, 9440.
- (63) Evans, C.; Scaiano, J. C.; Ingold, K. U. *J. Am. Chem. Soc.* **1992**, *114*, 4589.
- (64) Mukai, K.; Kageyama, Y.; Ishida, T.; Fukuda, K. *J. Org. Chem.* **1989**, *54*, 552.
- (65) Migliavacca, E.; Carrupt, P.-A.; Testa, B. *Helv. Chim. Acta* **1997**, *80*, 1613.
- (66) Neta, P.; Huie, R. E.; Maruthamuthu, P.; Steenken, S. *J. Phys. Chem.* **1989**, *93*, 7654.
- (67) Benson, S. W. *Thermochemical Kinetics*, 2nd ed.; Wiley: New York, 1976.
- (68) Arai, S.; Tremba, E. L.; Brandon, J. R.; Dorfman, L. M. *Can. J. Chem.* **1967**, *45*, 1119.
- (69) Nagaoka, S.-I.; Kuranaka, A.; Tsuboi, H.; Nagashima, U.; Mukai, K. *J. Phys. Chem.* **1992**, *96*, 2754.